

# BST106-M60S[L] Guide Rail Type

## Weighing / Force Measuring Control Module

Weight/Force Display, Peak Value Detection / Display Holding,  
Auto Weight-checking, Setpoint DO Output, AO/Digit Transmission

### Operation Manual V3.0

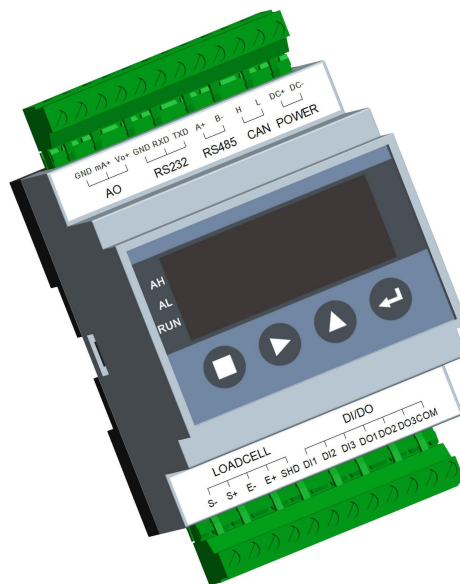

# Preface

Thank you very much for your purchase!

This manual covers safety precaution, technical specifications, user interfaces, installation& connection, functions&operation and so on. In order to make the product running at its best, please read this manual in advance, and reserve it for the future reading.

The technology update, function enhancement and quality improvement may lead to some differences between this manual and the physical product, please understand.

Without our authorization, the contents of this manual are not allowed to be copied and reproduced.

Main Features:

- ◇ Applications: Weight/Force Display, Peak Value Detection&Display Holding, Auto Weight-checking, Setpoint DO Output and AO/Digit Transmission.
- ◇ EMC design with high anti-jamming capability, suitable for industrial environment.
- ◇ 32-bit ARM CPU with 48MHz clock & high arithmetic speed.
- ◇ 6+6 Red LED digital tubes for English character and digit display.
- ◇ 4-key English keypad for Menu&Shortcut mode operation.
- ◇ 24-bit High-precision and high-speed  $\Sigma-\Delta$ /D conversion module with 1/1,000,000 internal resolution and max. sampling frequency 3200Hz.
- ◇ Special anti-vibration digital filtering algorithm for ensuring the weighing stability and accuracy when there is strong vibration on the load receptor, and the rapid response capability when the weight signal changes.
- ◇ Max. Connection Quantity: 8 Loadcells (350 $\Omega$ ).
- ◇ Zero Upon Power Up, Zero Auto-tracking, Manual/Auto Zero and Zero Calibration available.
- ◇ Load Calibration, Data Calibration, Segmenting Span Correction and Segmenting Weight Calculation available.
- ◇ Auto-locking, Key-locking, Key-unlocking, Digital Setting&Calibration and I/O Testing functions available.
- ◇ 3 Definable normally open switch inputs [DI] and 3 definable normally open transistor switch outputs [DO].
- ◇ 1 Optional&definable current signal output [AO: 0~20mA].
- ◇ 1 Optional&definable voltage signal output [VO: 0~10V].
- ◇ RS232, optional RS485 and CANBUS communication ports for connecting Host IPC/PLC and LED Remote Display.
- ◇ With the multitasking mode, the weighing/force measuring process, alarm output and signal transmission will not be interrupted by parameter setting and the other operations.

# Contents

<b>1. SAFETY PRECAUTION</b> .....	<b>3</b>
<b>2. TECHNICAL SPECIFICATIONS</b> .....	<b>4</b>
<b>3. USER INTERFACE</b> .....	<b>6</b>
3.1 USER INTERFACE DIAGRAM.....	6
3.2 STATE INDICATION.....	6
3.3 KEYPAD OPERATION.....	7
3.4 ALARM SIGNS.....	7
<b>4. INSTALLATION&amp;CONNECTION</b> .....	<b>8</b>
4.1 INSTALLATION.....	8
4.2 TERMINAL.....	9
<b>5. OPERATION PROCEDURE</b> .....	<b>11</b>
<b>6. FUNCTIONS&amp;OPERATION</b> .....	<b>12</b>
6.1 MAIN DISPLAY INTERFACES.....	12
6.1.1 Real-time Weight Value and Percent [L].....	12
6.1.2 Real-time Weight, Peak Hold Value or Checking-weight Value [P].....	12
6.1.3 Real-time Weight, AO Output Value [Ao].....	12
6.1.4 Real-time Weight, VO Output Value [Vo].....	13
6.1.5 Real-time Weight, Communication State [Co].....	13
6.2 MAIN MENU.....	14
6.3 F1-SET PARAMETER SETTING.....	16
6.3.1 Weighing Parameters (SCAL).....	16
6.3.2 Calibration Parameters (CALP).....	18
6.3.3 Setpoint Parameters (SEtP).....	20
6.3.4 Communication Parameters (SErP).....	23
6.3.5 Display Parameters (dISP).....	24
6.3.6 A Sample of Parameter Setting.....	25
6.4 F2-CAL SYSTEM CALIBRATION.....	26
6.4.1 Zero Calibration (ZEro).....	26
6.4.2 Data Calibration (dAtA).....	27
6.4.3 Load Calibration (LoAd).....	29
6.4.4 Segmenting Span Correction (SEgC).....	30
6.5 F5-LOC KEY-LOCKER.....	31
6.5.1 Key-unlocking (oPEn).....	31
6.5.2 Key-locking (LoCc).....	31
6.5.3 Password Set (PASS).....	32
<b>APPENDIX A. REGISTER TABLE OF HOST-SLAVE MODBUS[ASCII/RTU]</b> .....	<b>33</b>
<b>APPENDIX B. DATA FRAME FORMAT OF CONTINUOUS SENDING [ASCII]</b> .....	<b>36</b>



## 1. Safety Precaution

- **Application environment**

Make sure that this product works under the environment where is accord with the technical specifications.

Do not open the shell before power-off.

- **Cable Laying**

Weighing signal, analog signal and communication signal cables should be laid in pipes, and do not lay them together with power cables.

- **Power Supply**

The power supply of the controller should be separated from the power supply of the driving devices.

Please make sure that the inputted voltage is correct before power-on.

- **Environmental Protection**

While being discarded as worthless, the product should be processed lawfully as leady industrial waste for environment protection.

- **Other Notes**

The installation, wiring and maintenance should be operated by the engineers with the relevant professional knowledge and safety operation ability.

Although being not described in this manual, the relevant safety operating procedures and standards should be followed.

## 2. Technical Specifications

- Executing Standards
  - ◇ PRC GB/T 7724-2008 《National Standard for Electronic Weighing Meter》 .
  - ◇ PRC JJG 649-2016 《National Verification Regulation for Digital Weighing Indicators (Weighing Indicators)》 .
  - ◇ OMIL R76-1: 2006 《Non-automatic Weighing Instruments》 International Recommendation.
  - ◇ Accuracy Grade:  $\text{I}$  .
  - ◇ Number of Verification Scale Interval:  $n=3000$ .
- Display
  - ◇ 6+6 Red LED digital tubes for English character and digit display.
  - ◇ Weight Display Range:  $-9,999\sim+99,999$ .
  - ◇ Scale Capacity: Setting Range  $1\sim99,999$ .
  - ◇ Scale Division: Optional 1, 2, 5, 10, 20, 50, 100, 200, 500.
  - ◇ Display Resolution:  $1/50,000$ .
  - ◇ Decimal Point Position: Optional 0, 0.0, 0.00, 0.000, 0.0000.
  - ◇ Display Refreshing Time: Setting Range  $0.01\sim1.00\text{s}$ .
- Keypad
  - ◇ 4-key English keypad for Menu&Shortcut mode operation.
- Weighing Signal Interface
  - ◇ Excitation Voltage/Max. Current: DC5V/120mA [ $8\sim350\Omega$  loadcells].
  - ◇ Signal Input Range:  $0\sim12.5\text{mV}$ .
  - ◇ Output Sensitivity of Loadcell:  $1.0\sim2.5\text{mV/V}$ .
  - ◇ 24-bit  $\Sigma - \Delta$  ADC with internal resolution  $1/1,000,000$ .
  - ◇ Optional Sampling Frequency: 3200Hz, 1600Hz, 800Hz, 400Hz, 200Hz, 5Hz.
  - ◇ Special Anti-vibration Digital Filtering Algorithm for precise weighing, stable display and rapid response.
  - ◇ Zero Drift:  $\pm 0.1\mu\text{V}/^\circ\text{C}$  RTI (Relative to Input).
  - ◇ Gain Drift:  $\pm 5\text{ppm}/^\circ\text{C}$ .
  - ◇ Non-linearity:  $0.005\%\text{FS}$ .
- Switch&Analog Signal Interface
  - ◇ 3 Optional&definable normally open switch inputs [DI].
  - ◇ 3 Optional&definable normally open transistor switch outputs [DO]: DC24V, 250mA..
  - ◇ 1 Optional&definable current signal output [AO:  $0\sim20\text{mA}$ ], Non-linearity:  $0.05\%\text{FS}$ .
  - ◇ 1 Optional&definable voltage signal output [VO:  $0\sim10\text{V}$ ], Non-linearity:  $0.05\%\text{FS}$ .
- Digital Communication Interface
  - ◇ COM1: RS232.
  - ◇ COM2: Optional RS485.

- ◇ COM3: Optional CANBUS.
- ◇ Connectable: Host IPC/PLC and LED Remote Display.

□ Operating Specification

- ◇ Operating Voltage: DC12~24V.
- ◇ Max. Power Consumption: 3W.
- ◇ Outline Size: 71.5×113×57.9mm [W×H×D].
- ◇ Guide rail type installation.
- ◇ Guide Rail Groove Size: 35×1.6 mm [W×H×D].
- ◇ Operating Temperature: -25°C to +45°C.
- ◇ Storage Temperature: -30°C to +60°C.
- ◇ Relative Humidity: Max. 85%RH.
- ◇ Weight: Approx. 167g.

### 3. User Interface

#### 3.1 User Interface Diagram

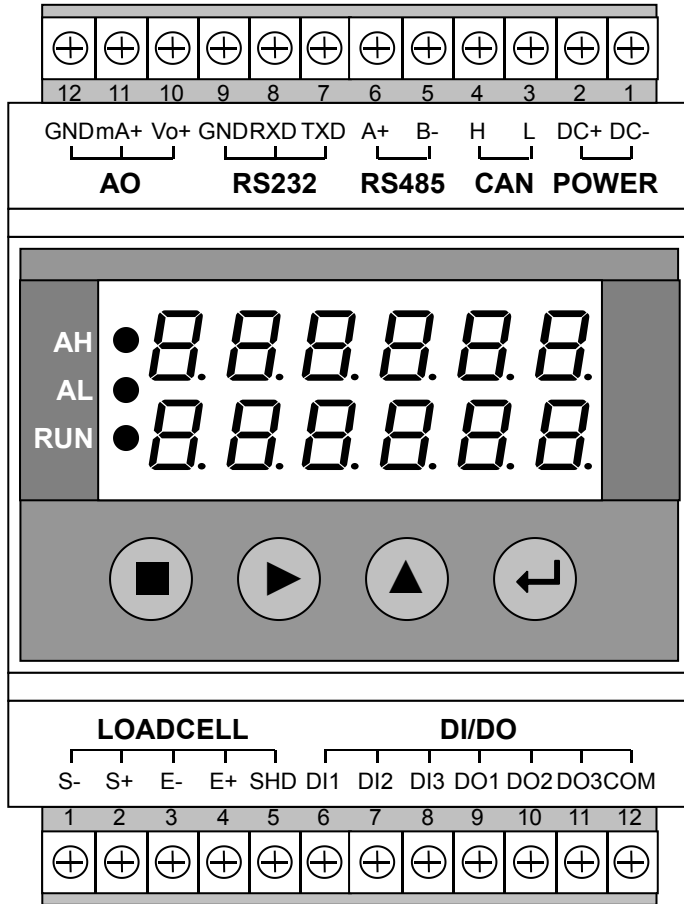

#### 3.2 State Indication

LED light	Description	Note
[AH]	Upper Limit Alarm.	Refer to Parameters [200]~[203].
[AL]	Lower Limit Alarm.	
[RUN]	Running State.	

### 3.3 Keypad Operation

If there is not any keypad operation in one minute and it's not in the processes of 'F2 System Calibration' & 'F6 Factory Adjustment', the controller will return to 'Main Display Interface' automatically.

Key Name	Function	Description
【■】	【MENU】	Enter Main Menu / Exit.
	【LOCK】*	Key-locking / Key-unlocking.
【▶】	【▶】	Cursor shifts right. Display the previous interface or option.
	【ZERO】*	Manual Zero without Power-down Protection.
【▲】	【▲】	Display the next interface or option. Digit input: +1 ( 0~9 loop).
	【SET】*	Setpoint Parameters Setting.
【↵】	【ENT】	Enter / Save / Clear Alarm.
	【CLS】*	Clear Screen [Clear the display value of Peak Hold Value and Weight-checking Value].

\*: Keep the key pressed for 2 seconds.

### 3.4 Alarm Signs

Sign	Alarm Cause	Solution
Err1	RAM Failure.	Replace the chip RAM.
Err2.1 Err2.2	EEPROM Failure.	Replace the chip EEPROM.
Err3	Unused.	
Err4	ADC Failure.	Replace the ADC module.
oV-Ad	Over ADC Range.	Weighing signal exceeds A/D conversion range. 1. Check if the loadcell is connected. 2. Check if the capacity of loadcell is too small. 3. Check if the loading weight is too big.
oL	Overload Alarm.	Gross Weight > (Scale Capacity + 9 × Scale Division). 1. Check if the loadcell is connected. 2. Check if the capacity of loadcell is too small. 3. Check if the loading weight is too big.
oV-nZ	Over 'Manual/Auto Zero Limit'.	Refer to parameter [123] 'Manual/Auto Zero Limit'.
tXX.XX	Preheating Time Countdown [min.sec].	Refer to parameter [128] 'Zero Upon Power Up', [129] 'Power Up Zero Time' and [130] 'Power Up Zero Limit'.
oV-Zr	Over 'Power Up Zero Limit'.	Wait for the preheating time over or press any key to exit.



## 4. Installation&Connection

### 4.1 Installation

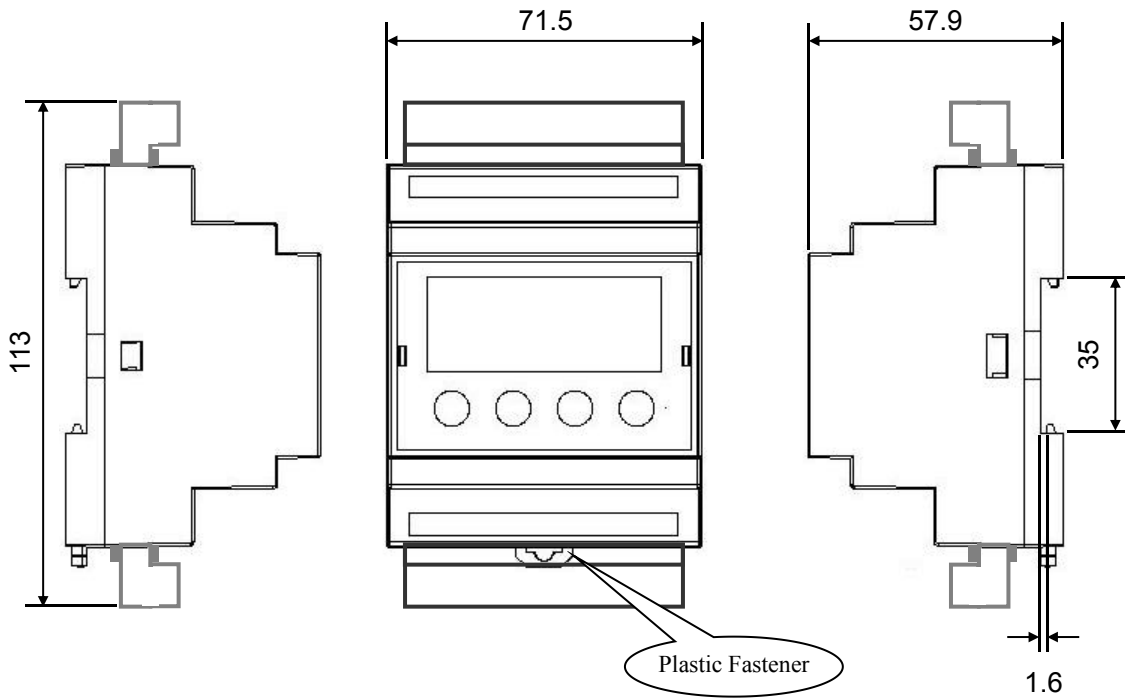

Outline Size W×H×D[mm]	Guide Rail Groove Size W×D[mm]
71.5×113×57.9	35×1.6

## 4.2 Terminal

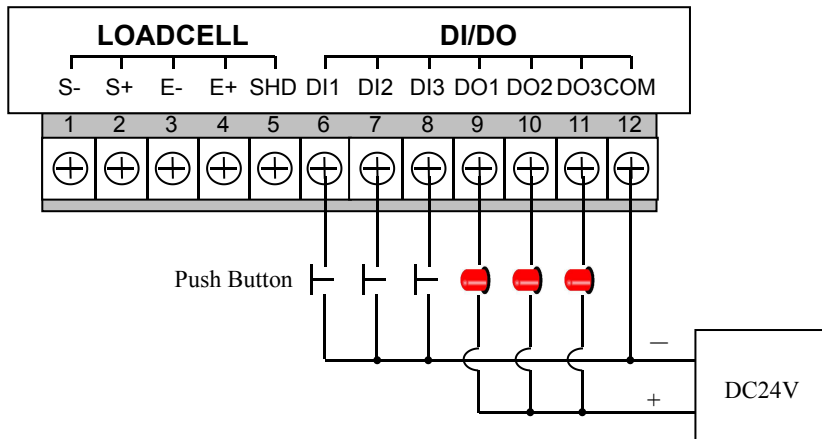

No.	Pin	Description
<b>LOADCELL</b>		<b>Loadcell Port</b>
1	S-	Weighing Signal Input +.
2	S+	Weighing Signal Input -.
3	E-	Excitation Voltage -.
4	E+	Excitation Voltage + [DC5V].
5	SHD	Shield Ground.
<b>DI/DO</b>		<b>Switch Input/Output Port [Definable]</b>
6	DI1	Switch Signal Input 1.
7	DI2	Switch Signal Input 2.
8	DI3	Switch Signal Input 3.
9	DO1	Normally Open Contact Output 1.
10	DO2	Normally Open Contact Output 2.
11	DO3	Normally Open Contact Output 3.
12	COM	DI/DO Common Terminal.
Contact Capacity of Transistor Switch: DC24V, 250mA.		

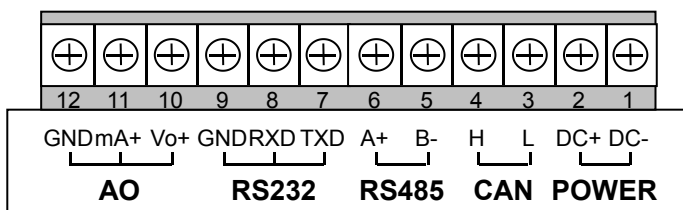

No.	Pin	Description
<b>POWER</b>		<b>DC12~24V Power Input Port</b>
1	DC-	DC Input -.
2	DC+	DC Input +.
<b>CAN [Optional]</b>		<b>CANBUS Digital Communication Port [COM3]</b>
3	L	Data -.
4	H	Data +.
<b>RS485</b>		<b>RS485 Digital Communication Port [COM2]</b>
5	B-	Data -.
6	A+	Data +.
<b>RS232</b>		<b>RS232 Digital Communication Port [COM1]</b>
7	TXD	Transmit Data.
8	RXD	Receive Data.
9	GND	Signal Ground.
<b>AO</b>		<b>Analog Output Port [Definable]</b>
10	Vo+	0~10V Voltage Signal Output] +.
11	mA+	0~20mA Current Signal Output +.
12	GND	VO/AO Output -.

## 5. Operation Procedure

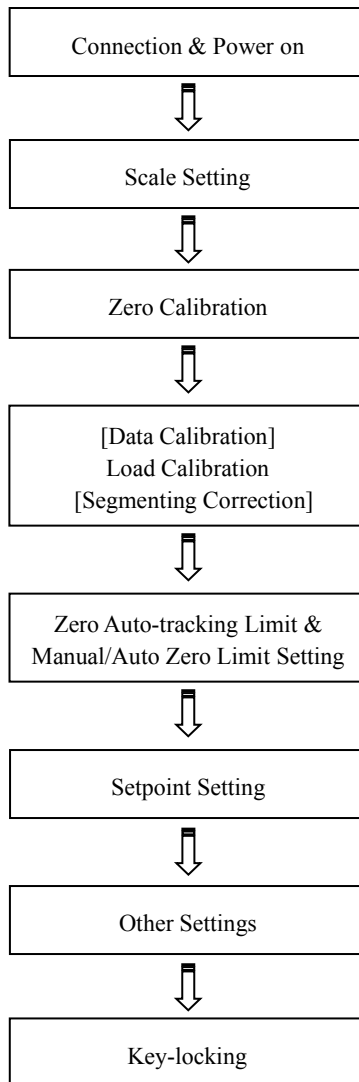

## 6. Functions&Operation

### 6.1 Main Display Interfaces

【▶】【▲】 : Display interface switch.

#### 6.1.1 Real-time Weight Value and Percent [L]

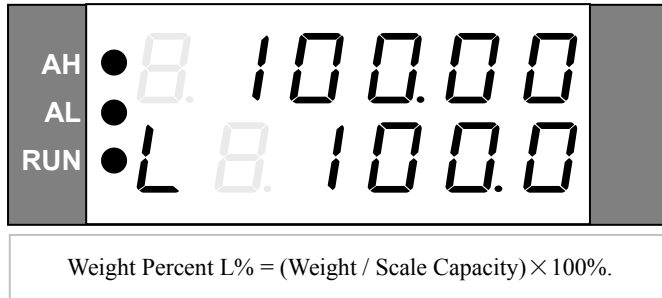

#### 6.1.2 Real-time Weight, Peak Hold Value or Checking-weight Value [P]

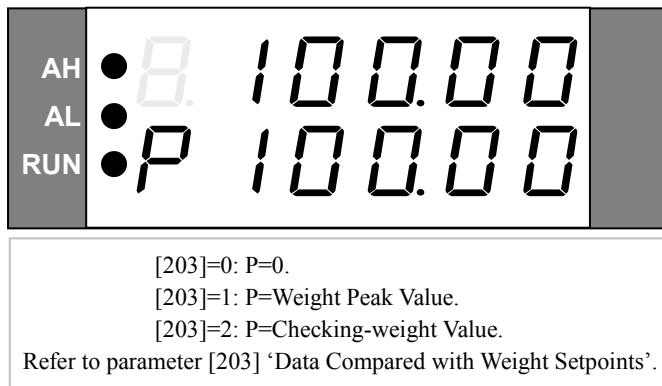

#### 6.1.3 Real-time Weight, AO Output Value [Ao]

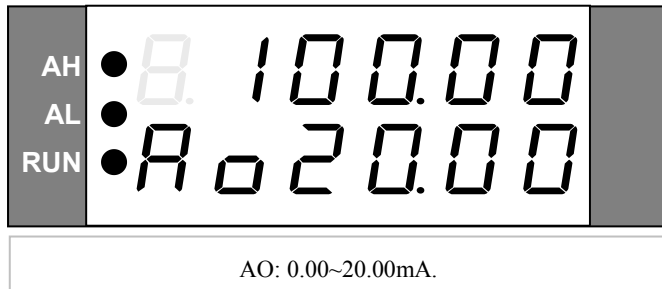

### 6.1.4 Real-time Weight, VO Output Value [Vo]

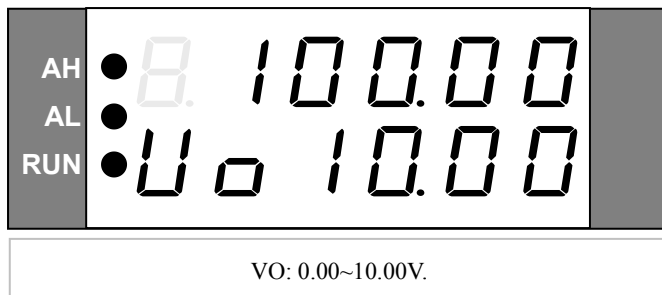

### 6.1.5 Real-time Weight, Communication State [Co]

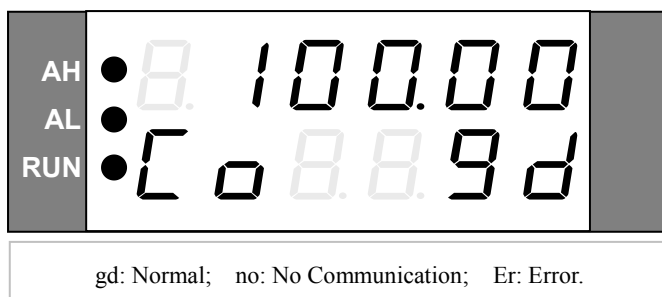

## 6.2 Main Menu

Main Menu		Second Menu	
Sign	Function	Sign	Description
F1.SET	Parameter Setting	-SCAL	Scale parameters setting.
		-CALP-	Calibration parameters setting.
		-SEtP-	Setpoint parameters setting.
		-SErP-	Communication parameters setting.
		-dISP-	User interface parameters setting.
F2.CAL	System Calibration	-ZEro-	Zero Calibration without loading on the weigher to correct Zero Value.
		-dAtA-	Data Calibration: Input the specification parameter values of loadcell according to the actual configuration of the weighing system to correct Span Coefficient. If there is no access to get the specification parameter values for Data Calibration, then it's necessary to do Load Calibration.
		-LoAd-	Load Calibration: After doing Data Calibration, if there are conditions for Load Calibration, do Load Calibration with loading standard weight on the weigher to correct Span Coefficient further for higher weighing accuracy.
		-SEgC-	Segmenting Span Correction: After doing Zero Calibration and Load Calibration [or Data Calibration], it's allowed to do Segmenting Span Correction with loading standard weight on the weigher by 10 Correction Points to get Span Correction Ratio of 10 linearity segments for higher weighing accuracy.
F3.rEC			Unused.
F4.CLn			Clear Screen: Clear the display value of Peak Hold Value and Weight-checking Value.
F5.Loc	Key-locker	-oPEn-	Key-unlocking.
		-LoCC-	Key-locking.
		-PASS-	Password Set. Exfactory Passwords: ✧ Operator Password: 000. ✧ Administrator Password: 001.

Main Menu		Second Menu	
F6.FAC	Factory Adjustment	Special for manufacturer.	
		-SPAN-	【 mV 】 Exfactory Span Adjustment: Use standard weighing test equipment to adjust the weighing signal interface for normalizing Span Coefficient to 1.
		-AdtS-	Weighing Signal Linearity Test.
		-AVZF-	AO [0~20mA] Zero/Full Adjustment. VO [0~10V] Zero/Full Adjustment.
		-AVtS-	AO [0~20mA] Linearity Test. VO [0~10V] Linearity Test.
		-dIdo-	DI/DO Input&Output Test.
		-dEFU-	RAM Reset: Reset to factory defaults.
		-dStS-	Display/DO Reliability Test.
F7.InF	Product Information	Only for query.	
		--VEr-	Version No.
		--Sn--	Serial No.
		-dAtE-	Exfactory Date.
		-HARd-	Hardware Configuration.



## 6.3 F1-SET Parameter Setting

### 6.3.1 Weighing Parameters (SCAL)

No.	Sign	Range	Default	Description	Set
100	Ut	0~3	1	<b>Weight Unit</b> 0: None 1: kg 2: t 3: g	
101	dt	0~4	000.00	<b>Decimal Point Position</b> 0: 00000 1: 0000.0 2: 000.00 3: 00.000 4: 0.0000	
102	SL	1~99999	10000	<b>Scale Capacity</b> Max. allowed loading weight of the load receptor. Scale Capacity $\leq$ (Loadcell Capacity $\times$ Loadcell Quantity) – Self-weight of Load Receptor.	
103	dV	1~500	1	<b>Scale Division</b> 1, 2, 5, 10, 20, 50, 100, 200, 500	
104	ZE	-99999~ +99999	0 [*]	<b>Zero Value</b> Only for query.	
105	SP	>0	1.0000 [*]	<b>Span Coefficient</b> Max. display value: 9.9999. Only for query.	
106	Sr	0~5	0	<b>Stability Range [Division]</b> Set value = 0: No 'Stability Judging'. Set value > 0: Weight Variance per [107] 'Stability Time' being in [106] 'Stability Range' means 'Weight is stable'.	
107	St	0.1~9.9	0.5	<b>Stability Time [s]</b>	

[\*]: 'RAM Reset' operation has no effect on the parameter.

No.	Sign	Range	Default	Description	Set	
108	Fc	0~5	0	<b>Sampling Frequency [Hz]</b> <i>0: 5 Hz</i> <i>1: 200 Hz</i> <i>2: 400 Hz</i> <i>3: 800 Hz</i> <i>4: 1600Hz</i> <i>5: 3200Hz</i>		
109	Ft	0~9	5	<b>Anti-vibration Digital Filter1</b>		
				Set Value		Cutoff Frequency
				0		None
				1		11.2Hz
				2		8.0Hz
				3		5.6Hz
				4		4.0Hz
				5		2.8Hz
				6		2.0Hz
				7		1.4Hz
				8		1.0Hz
9	0.7Hz					
110	Sb	1~128	1	<b>Weight Display Smooth Filter2</b> The bigger set value of Filter2 will make the weight display value more stable with slower response speed.		
111	EL	0.01~9999.99	1	<b>Weight Display Multiplier</b> It's for enlarging or lessening the weight display value.		

[\*]: 'RAM Reset' operation has no effect on the parameter.

### 6.3.2 Calibration Parameters (CALP)

No.	Sign	Range	Default	Description	Set
120	ZP	0~1	0	<b>Zero Auto-tracking Permission</b> <i>0: oFF</i> <i>1: on</i> [Only after weight being stable and the zero variation in ‘Zero Auto-tracking Time’ is within the range of ‘Zero Auto-tracking Limit’, the result of Zero Auto-tracking will be valid]	
121	Zt	0.1~9.9	1.0	<b>Zero Auto-tracking Time [s]</b>	
122	Zr	0.1~50.0	1.0	<b>Zero Auto-tracking Limit [Division]</b>	
123	nZ	0~50000	50	<b>Manual/Auto Zero Limit</b> Only when the weight variation caused by Zero Value changing is within this range, Manual Zero and Auto Zero will be valid. Suggestion: Set value $\leq$ (Scale Capacity $\times$ 4%).	
124	dZ	0~99	5	<b>Zero Display Limit</b> When the absolute value of weight is within this range, the weight display value will return to zero.	
125	tL	1~99999	12000 [*]	<b>Total Capacity of Loadcells</b> Total Capacity of Loadcells = Loadcell Capacity $\times$ Loadcell Number. Only for query.	
126	SE	0.500~5.000	2.000 [*]	<b>Output Sensitivity of Loadcell [mV/V]</b> Only for query.	
127	Un	0	0	<b>Unused</b>	
128	In	0~1	0	<b>Zero Upon Power Up</b> <i>0: oFF</i> <i>1: on</i> [without Power-down Protection]	
129	It	0~1800	10	<b>Power Up Zero Time [s]</b>	
130	Ir	0~50000	50	<b>Power Up Zero Limit</b> Suggestion: Set value $\leq$ (Scale Capacity $\times$ 20%).	

[\*]: ‘RAM Reset’ operation has no effect on the parameter.

No.	Sign	Range	Default	Description	Set
131	L1	1~99999 [*]	1000	<b>Correction Point's Loading Weight 1~10</b> Inputted Loading Weight value for Segmenting Correction. Demand: $L1 \leq L2 \leq \dots \leq L10$ . Only for query.	
132	L2				
133	L3				
134	L4				
135	L5				
136	L6				
137	L7				
138	L8				
139	L9				
140	LA[L10]				
141	d1	-99999~ +99999 [*]	10000	<b>Correction Point's AD Value 1~10</b> AD Value detected via Segmenting Correction. Demand: $d1 \leq d2 \leq \dots \leq d10$ . Only for query.	
142	d2				
143	d3				
144	d4				
145	d5				
146	d6				
147	d7				
148	d8				
149	d9				
150	dA[d10]				
151	C1	0.0100~ 99.9999 [*]	1.0000	<b>Span Correction Ratio 1~10</b> Span Correction Ratio of Linearity Segment got by Segmenting Correction. ◇ Linearity Segment 1: [Zero Value]~d1. ◇ Linearity Segment 2: d1~d2. ◇ Linearity Segment 3: d2~d3. ◇ ... ◇ Linearity Segment 10: d9~[Max. AD Value]. Max. display value: 9.9999. Only for query.	
152	C2				
153	C3				
154	C4				
155	C5				
156	C6				
157	C7				
158	C8				
159	C9				
160	CA[C10]				
161	SC	0~1	0 [*]	<b>Segmenting Weight Calculation Permission</b> 0: <i>oFF</i> 1: <i>on</i> Operating Authorization: Administrator.	

[\*]: 'RAM Reset' operation has no effect on the parameter.

### 6.3.3 Setpoint Parameters (SEtP)

No.	Sign	Range	Default	Description	Set
200	P1	0~99999	1000	<b>Weight Setpoint 1</b>	
201	P2	0~99999	9000	<b>Weight Setpoint 2</b>	
202	nL	0~50000	50	<b>Non-load Zero Range</b>	
				<b>Peak Value Detection:</b> ‘Weight > Non-load Zero Range’ for triggering the peak value detection process. ‘Weight ≤ Non-load Zero Range’ for stopping the peak value detection process.	
				<b>Auto Weight-checking:</b> <b>Switch Triggering Mode:</b> If the DI switch ‘Weight-checking Photo-electric Identification’ is defined, the weight-checking process will be triggered when the DI switch turns on. <b>Weight Triggering Mode:</b> If the DI switch ‘Weight-checking Photo-electric Identification’ is not defined, the weight-checking process will be triggered when ‘Weight > Non-load Zero Range’.  Once ‘Weight ≤ Non-load Zero Range’ or ‘Weight-checking Time ≥ [212] Weight-checking Timeout’, the weight-checking process will end automatically.	
				Refer to parameters [213]~[215] ‘DI1/DI2/DI3 Signal’.	
203	dA	0~2	0	<b>Data Compared with Weight Setpoints</b> 0. <i>nEt</i> [Real-time Weight] 1. <i>PnEt</i> [Weight Peak Value] 2. <i>CHC</i> [Checking-weight Value]	
204	do	0~1	1	<b>DO Output Permission</b> 0: <i>oFF</i> 1: <i>on</i>	

No.	Sign	Range	Default	Description	Set
205	dL	0.0~5.0	0.5	<b>DO Bounce-back Delay Time [s]</b> Used for avoiding that the DO alarm switch turns on and off frequently with its related real-time data being at the critical point.	
				<b>Min. Interval Time for Peak Value Detection [s]</b> Only after the time delayed, the triggered peak value detection process is allowed to be stopped by 'Weight $\leq$ Non-load Zero Range'. And only after the time delayed, the stopped peak value detection process is allowed to be triggered again by 'Weight $>$ Non-load Zero Range'.	
				<b>Weight-checking Anti-bounce Time [s]</b> After the weight-checking process triggered, if 'Weight $\leq$ Non-load Zero Range' in this time, then the weight-checking process will be invalid.	
206	Ao	0~1	0	<b>AO Signal</b> <i>0. nEt</i> [Real-time Weight] <i>1. PnEt</i> [Peak Value or Checking-weight Value]	
207	AE	0.00~21.00	4.00	<b>AO Current Low Limit Value [mA]</b>	
208	AF	0.00~21.00	20.00	<b>AO Current High Limit Value [mA]</b>	
209	VE	0.00~10.00	0.00	<b>AO Voltage Low Limit Value [V]</b>	
210	VF	0.00~10.00	10.00	<b>AO Voltage High Limit Value [V]</b>	
211	AC	1~99999	10000	<b>Max. Weight Value for AO Output</b> Weight $\geq$ [211]: AO= High Limit Value. Weight $\leq$ 0: AO=Low Limit Value.	
212	CHC	0.00~9.99	1.00	<b>Weight-checking Timeout [s]</b> Once 'Weight-checking Time $\geq$ Set Value', the weight-checking process will end automatically.	

No.	Sign	Range	Default	Description	Set
213 214 215	dI1 dI2 dI3	0~6 [*]	0 1 2	<p><b>DI1/DI2/DI3 Signal</b></p> <p>0. <math>\equiv Z_{Ero}</math> [Manual Zero without Power-down Protection]</p> <p>1. <math>-Z_{Ero}</math> [Zero Calibration with Power-down Protection]</p> <p>2. <math>-CLS-</math> [Clear Screen]</p> <p>3. <math>Id</math> [Weight-Checking Photo-electric Identification for identifying the unchecked product entering the weigher]</p> <p>4. <math>StSP</math> [Start/Stop Peak Value Detecting or Weight-checking Process]</p> <p>5. <math>StArt</math> [Start Peak Value Detecting or Weight-checking Process]</p> <p>6. <math>StoP</math> [Stop Peak Value Detecting or Weight-checking Process]</p> <p>Operating Authorization: Administrator.</p>	
216 217 218	do1 do2 do3	0~12 [*]	1 2 3	<p><b>DO1/DO2/DO3 Signal</b></p> <p>0. <math>Z_{Ero}</math> [Weight <math>\leq</math> Non-load Zero Range]</p> <p>1. <math>L1</math> [203]&lt;P1</p> <p>2. <math>I \equiv 2</math> <math>P1 \leq [203] \leq P2</math></p> <p>3. <math>b2</math> [203]&gt;P2</p> <p>4. <math>LE1</math> [203]<math>\leq</math>P1</p> <p>5. <math>I-2</math> <math>P1 &lt; [203] &lt; P2</math></p> <p>6. <math>b2</math> [203]<math>\geq</math>P2</p> <p>7. <math>b1</math> [203]&gt;P1</p> <p>8. <math>bE1</math> [203]<math>\geq</math>P1</p> <p>9. <math>L2</math> [203]&lt;P2</p> <p>10. <math>LE2</math> [203]<math>\leq</math>P2</p> <p>11. <math>CHC</math> [Peak Value Detection Finished or Weight-checking Finished]</p> <p>12. <math>run</math> [Running State]</p> <p>Note:  'L': Less than; 'LE': Less than or Equal to.  'b': Bigger than; 'bE': Bigger than or Equal to.  '<math>\equiv</math>': Closed interval; '-': Open interval.</p> <p>Operating Authorization: Administrator.</p>	

[\*]: 'RAM Reset' operation has no effect on the parameter.

### 6.3.4 Communication Parameters (SErP)

No.	Sign	Range	Default	Description	Set	
800	Ad	0~99	1	<b>Communication Address</b>		
801	b1	0~2	0	<b>COM1/COM2 Baud Rate</b> <i>0: 9600bps</i> <i>1: 19200bps</i> <i>2: 115200bps [1152d]</i>		
802	b2		0			
803	P1	0~2	0	<b>COM1/COM2 Parity Check</b> <i>0. none</i> [None Check] <i>1. EVEn</i> [Even Check] <i>2. odd</i> [Odd Check]		
804	P2		0			
805	E1	0~2	0	<b>COM1/COM2 Communication Mode</b> <i>0. HASC</i> [Host-slave, Modbus ASCII] <i>1. Hrtu</i> [Host-slave, Modbus RTU] <i>2. Cont</i> [Continuous Sending ASCII]		
806	E2		0			
807	dA	0~1	0	<b>Data for Continuous Sending Mode</b> <i>0. nEt</i> [Real-time Weight] <i>1. PnEt</i> [Peak Value or Checking-weight Value]		
808	SF	0~9	2	<b>Continuous Sending Frequency [Hz]</b> <i>0: 1Hz; 1: 2Hz; 2: 5Hz; 3: 10Hz</i> <i>4: 20Hz; 5: 25Hz; 6: 50Hz; 7: 100Hz</i> <i>8: 500Hz; 9: 1000Hz</i>		
				COM1 Baud Rate		Max. Sending Frequency
				9600bps		50Hz
				19200bps		100Hz
				115200bps	1000Hz	
809	dF	0~3	0	<b>Modbus Data Format</b> Reading&Writing Order of 4-Byte Registers: <i>0: 4321</i> [HB4 HB3 LB2 LB1] <i>1: 3412</i> [HB3 HB4 LB1 LB2] <i>2: 1234</i> [LB1 LB2 HB3 HB4] <i>3: 2143</i> [LB2 LB1 HB4 HB3]  The HEX byte order of float and long int registers in the controller is 'HB4 HB3 LB2 LB1'.		



### 6.3.5 Display Parameters (dISP)

No.	Sign	Range	Default	Description	Set
901	dS	0.01~1.00	0.20	<b>Display Refreshing Time [s]</b>	
902	Lc	0~1	0	<b>Auto-Locking</b> <i>0: oFF</i> <i>1: on</i> [If there is not any keypad operation in one minute and it's not in the processes of 'F2 System Calibration' & 'F6 Factory Adjustment', the controller will lock the keypad and return to 'Main Display Interface' automatically]	
903	br	1~4	2	<b>LED Brightness</b>	

[\*]: 'RAM Reset' operation has no effect on the parameter.

### 6.3.6 A Sample of Parameter Setting

Modify the parameter '[102] Scale Capacity'.

Main Display Interface

↓ **【■】 + 【▶】【▲】** : F1-SEt  
**【←】 + 【▶】【▲】**

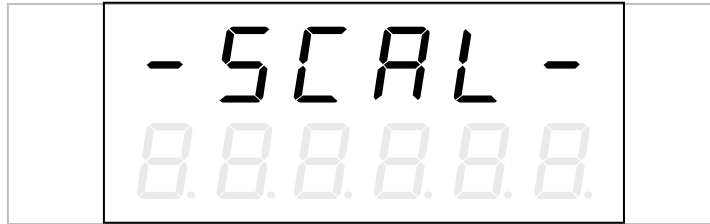

↓ **【←】 + 【▶】【▲】**

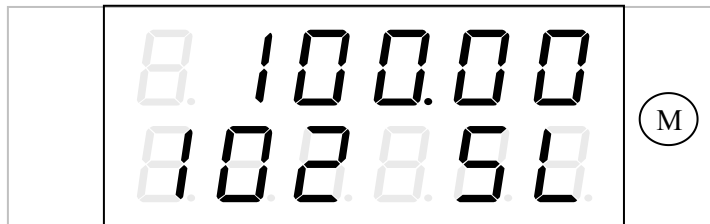

↓ **【←】**

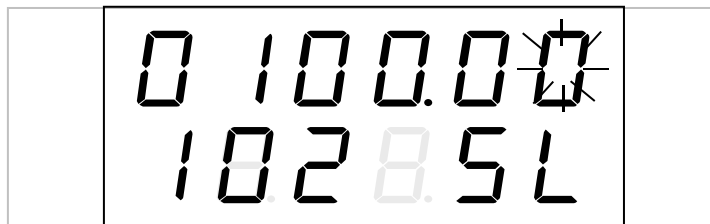

**【▶】** : Moving cursor; **【▲】** : Digit input.

**【■】** : Exit ↓ **【←】** : Save



## 6.4 F2-CAL System Calibration

After doing 'System Calibration', Tare Weight value will return to zero automatically.

### 6.4.1 Zero Calibration (ZEro)

Do Zero Calibration without loading on the weigher and save the new Zero Value.

Main Display Interface

(M) ↓ **【■】 + 【▶】【▲】** : F2-CAL  
**【←】 + 【▶】【▲】** : -ZEro-  
**【←】**

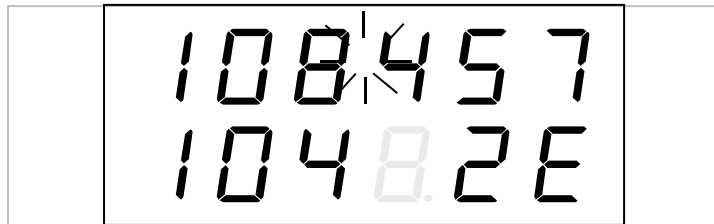

**【▶】【▲】** :

- ◇ 104: New Zero Value.
- ◇ oLd: Original Zero Value.
- ◇ Er: Error = New Value - Original Value.

If Zero Value exceeds allowed range, it's not allowed to be saved.









**【■】** : Exit ↓ **【←】** : Save

(M)

## 6.4.2 Data Calibration (dAtA)



Input the specification parameter values of loadcell [Total Capacity and Output Sensitivity] according to the actual configuration of the weighing system to correct Span Coefficient. If there is no access to get the specification parameter values for Data Calibration, then it's necessary to do Load Calibration.

Main Display Interface

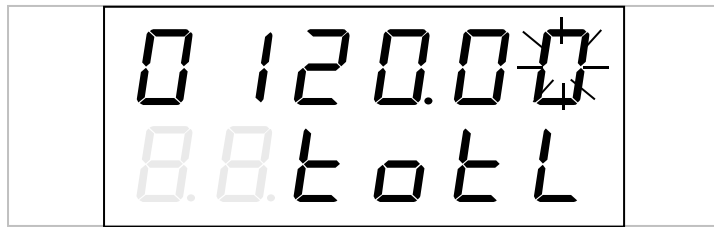

 +   : F2-CAL  
 +   : -dAtA-  



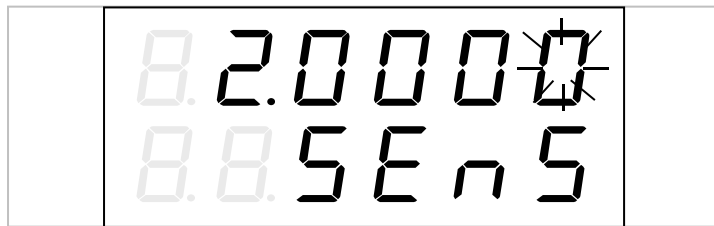

Input 'Total Capacity of Loadcells' [totL]: 1~999999 Weight Unit.





Input 'Output Sensitivity of Loadcell' [SEnS]: 0.5000~5.0000mV/V.

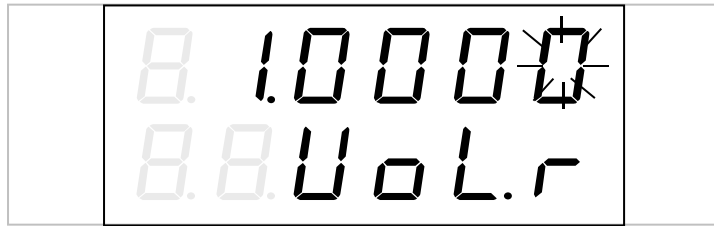

Input 'Voltage Ratio' [VoL.r]: 1.0000~2.0000.

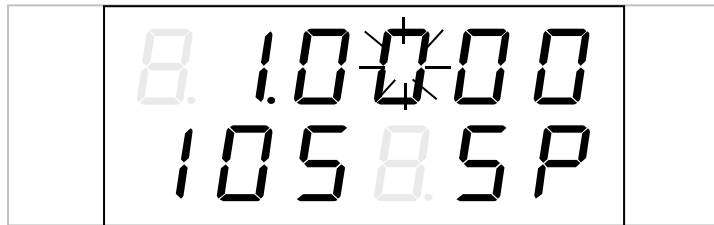

【▶】【▲】:

- ◇ 105: New Span Coefficient value.
- ◇ oLd: Original Span Coefficient value.
- ◇ Sr: Span Correction Ratio = New Value / Original Value.

【■】: Exit ↓ 【↔】: Save



Note:

- ◇ Total Capacity of Loadcells = Loadcell Capacity × Quantity.
- ◇ Voltage Ratio = Excitation Voltage on the terminal of controller / Excitation Voltage on the terminal of loadcells.
- ◇ The rated excitation voltage for loadcells is DC9V. It's best to measure the actual voltage value.
- ◇ 4-wire connection: The voltage attenuation is big, the voltage on both sides should be measured.

### 6.4.3 Load Calibration (LoAd)

After doing Data Calibration, if there are conditions for Load Calibration, do Load Calibration with loading standard weight on the weigher to correct Span Coefficient further for higher weighing accuracy. The loading weight should be bigger than 50% of Scale Capacity value.

Main Display Interface

 ↓ **【■】 + 【▶】【▲】** : F2-CAL  
**【←】 + 【▶】【▲】** : -LoAd-  
**【←】**

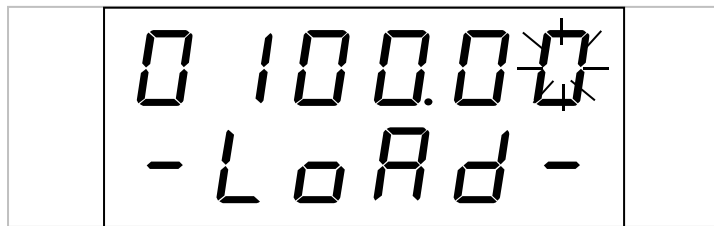

Input 'Calibrating Weight': 1~999999 Weight Unit.

↓ **【←】**

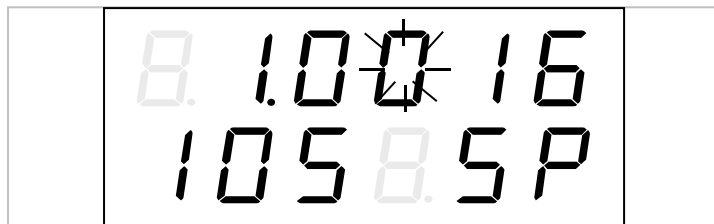

**【▶】【▲】** :

- ◇ 105: New Span Coefficient value.
- ◇ oLd: Original Span Coefficient value.
- ◇ Sr: Span Correction Ratio = New Value / Original Value.
- ◇ Ad: AD Value.

If AD Value ≤ Zero Value, display 'Err', and it's not allowed to save Span Coefficient.

**【■】** : Exit ↓ **【←】** : Save



### 6.4.4 Segmenting Span Correction (SEgC)

After doing Zero Calibration and Load Calibration [or Data Calibration], it's allowed to do Segmenting Span Correction with loading standard weight on the weigher by 10 Correction Points to get Span Correction Ratio of 10 linearity segments for higher weighing accuracy.

Main Display Interface

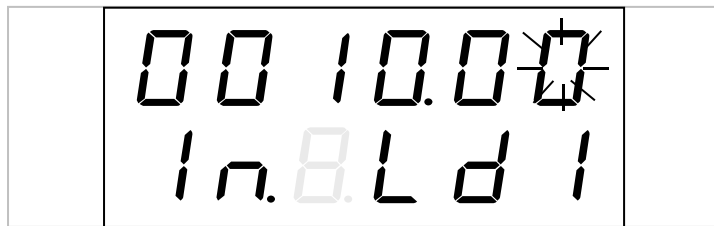

 【■】 + 【▶】 【▲】 : F2-CAL  
 【←】 + 【▶】 【▲】 : - SEgC -  
 【←】



Loading 'Correction Point's Loading Weight 1' on the weigher, then Input 'Loading Weight 1': 1~99999 Weight Unit.

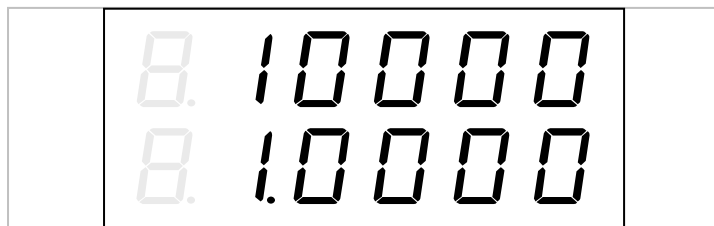

 【←】 : Display AD Value & Span Correction Ratio 1.



 After AD Value is stable, press 【←】 to save [151] Span Correction Ratio 1.

#### Enter the next point's correction process.

- ◇ It's free to exit by pressing key 【■】.
- ◇ Number of Linearity Segments = Number of Finished Correction Points.
- ◇ Parameter [161] is used to open/close 'Segmenting Weight Calculation'.

 After AD Value is stable, press 【←】 to save [160] Span Correction Ratio 10.



 M

## 6.5 F5-LOC Key-locker

### 6.5.1 Key-unlocking (oPEn)

Main Display Interface

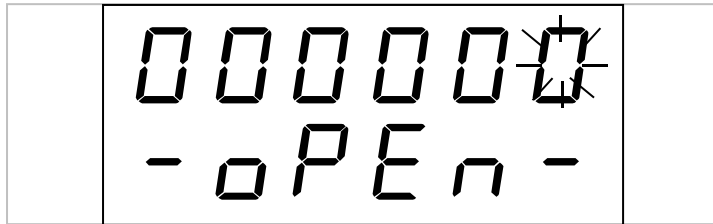
(M) ↓ **【■】 + 【▶】【▲】** : F5-Loc  
**【←】 + 【▶】【▲】** : -oPEn-  
**【←】**



↓ **【←】** : If inputted password is correct,  
Key-unlocking will be valid.

(M)

### 6.5.2 Key-locking (Loce)

Main Display Interface

(M) ↓ **【■】 + 【▶】【▲】** : F5-Loc  
**【←】 + 【▶】【▲】** : -Loce-  
**【←】**

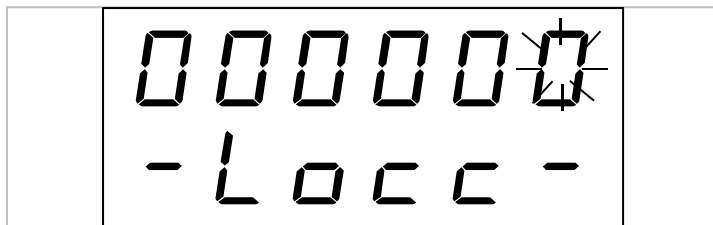



↓ **【←】** : If inputted password is correct,  
Key-locking will be valid.

(M)



### 6.5.3 Password Set (PASS)

Main Display Interface



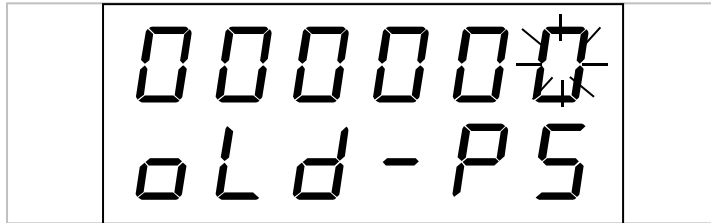

 【■】 + 【▶】【▲】 : F5-Loc  
 【←】 + 【▶】【▲】 : -PASS-  
 【←】



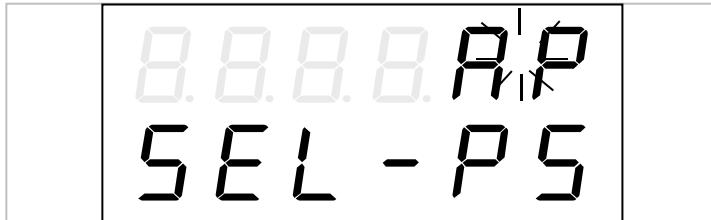





If inputted is Operator Password, this operation interface will be skipped; if inputted is Administrator Password, 'Administrator Password [AP]' or 'Operation Password [oP]' can be modified via 【▶】 【▲】.

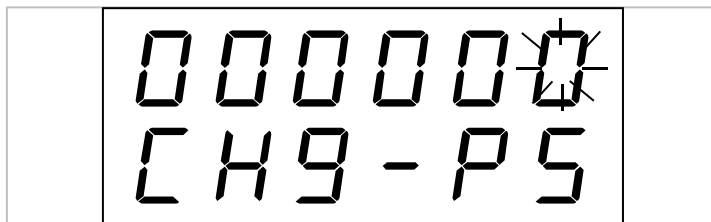



Input the new Password. Please remember it.

【■】 : Exit 
 : Save



## Appendix A. Register Table of Host-Slave MODBUS[ASCII/RTU]

Data Name	Type	Address	Attribute	Command [HEX]	Description
Real-timeWeight	Long	40001	R	03	
Real-time Weight	Long	40003	R	03	Preset Parameter [203]=0.
Weight Peak Value					Preset Parameter [203]=1.
Checking-weight					Preset Parameter [203]=2.
Running State 1	UnShort	40005.0	R	03	1: Running State.
		40005.1			1: Peak Value Detection Finished or Weight-checking Finished.
		40005.2			
		40005.3			
		40005.4			
		40005.5			
		40005.6			
		40005.7			
		40005.8			
		40005.9			
		40005.10			
		40005.11			
		40005.12			
		40005.13			1: Weight is stable.
		40005.14			1: Overload Alarm.
40005.15	1: Controller Fault.				
Running State 2 [Unused]	UnShort	40006.0	R	03	
		40006.1			
		40006.2			
		40006.3			
		40006.4			
		40006.5			
		40006.6			
		40006.7			
		40006.8			
		40006.9			
		40006.10			
		40006.11			
		40006.12			
		40006.13			
		40006.14			
40006.15					

Data Name	Type	Address	Attribute	Command [HEX]	Description
DO State	UnShort	40007.0	R	03	1: DO1 ON; 0: DO1 OFF.
		40007.1			1: DO2 ON; 0: DO2 OFF.
		40007.2			1: DO3 ON; 0: DO3 OFF
		40007.3			
		40007.4			
		40007.5			
		40007.6			
		40007.7			
		40007.8			
		40007.9			
		40007.10			
		40007.11			
		40007.12			
		40007.13			
		40007.14			
40007.15					
Operation	UnShort	40008	W	06	0xA500: Unused. 0xA501: Unused. 0xA502: Unused. 0xA503: Unused. 0xA504: Unused. 0xA505: Unused. 0xA506: Unused. 0xA507: Unused. 0xA508: Unused. 0xA509: Unused. 0xA50A: Clear Screen. 0xA50B: Unused. 0xA50C: Clear Alarm. 0xA50D: Manual Zero. 0xA50E: Zero Calibration. 0xA50F: Load Calibration [Do Span Calibration with the value of 'Calibrating Weight' as loading weight]. 0xA510~0xA5FF: Unused.
Calibrating Weight	UnLong	40009	R/W	03/10	
	UnLong	40011	R	03	
	UnLong	40013	R	03	

Data Name	Type	Address	Attribute	Command [HEX]	Description
	UnLong	40015	R	03	
Non-load Zero Range	UnShort	40017	R/W	03/06	
Weight Setpoint 1	UnLong	40018	R/W	03/10	
Weight Setpoint 2	UnLong	40020	R/W	03/10	
Weight Peak Value	UnLong	40022	R	03	
	UnLong	40024	R/W	03/10	
Data Compared with Weight Setpoints	UnShort	40026	R/W	03/06	0: Real-time Weight. 1: Weight Peak Value. 2: Checking-weight.
	UnShort	40027	R/W	03/06	
	UnShort	40028	R/W	03/06	
	UnShort	40029	R/W	03/06	
	UnShort	40030	R/W	03/06	
	UnShort	40031	R/W	03/06	
	UnShort	40032	R/W	03/06	
	UnShort	40033	R/W	03/06	
	UnLong	40034-40037	W	10	
	UnShort	40038	W	06	
Key Code	UnShort	40039	R	06	0x02: <b>【 ■ 】</b> ( <b>【MENU】</b> ) 0x04: <b>【 ▶ 】</b> 0x40: <b>【 ▲ 】</b> 0x80: <b>【 ↵ 】</b> ( <b>【ENT】</b> )
Serial No.	UnLong	40040	R	03	6 Digits.

UnShort: Unsigned Short Int; UnLong: Unsigned Long Int; Long: Signed Long Int.

## Appendix B. Data Frame Format of Continuous Sending [ASCII]

Field Name		Code	HEX	Description	Example
START [Byte1]		=	3D		=
Weighing State [Byte2]		O	4F	Overload	S
		S	53	Stable	
		M	4D	Motion	
Data Name [Byte3]		G	47	Unused	N
		N	4E	Weight	
		P	50	Weight Peak Value or Checking-weight Value	
		B	42	Unused	
		T	54	Unused	
		D	44	Unused	
		U	55	Unused	
Data [9 Bytes]	Weight Data [Byte4~12]	+/-	2B/2D	Sign	+00123.4k [DEC]
		Weight Value [7 Bytes]	30~39 2EH	0~9 Decimal Point ‘.’	
		Unit [1 Byte]: (Space)	20	Space: None	
		k t g	6B 74 67	k: kg	
SUM Check [Byte13]		1 Byte	XX	SUM=Byte1+Byte2+...+Byte12	
END [Byte14~15]		<CR> <LF>	0D 0A		<CR> <LF>

Example: Sending Weight Data ‘+00123.4kg’

Byte	Field Name	HEX	Note
1	START	3D	=
2	Weighing State	53	S
3	Data Name	4E	N
4	Sign	2B	+
5	Weight Value	30	0
6	Weight Value	30	0
7	Weight Value	31	1
8	Weight Value	32	2
9	Weight Value	33	3
10	Weight Value	2E	.
11	Weight Value	34	4
12	Unit	6B	k
13	SUM	CC	SUM=Byte1+Byte2+...+Byte12
14	END	0D	<CR>
15	END	0A	<LF>